

# Montage mur d'image courbe

## Montage de la structure 2,4 m et 3m

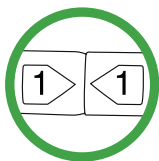

**1** Assemblez les différentes sections à élastique en connectant les embouts ayant le même numéro à l'aide du bouton-poussoir.

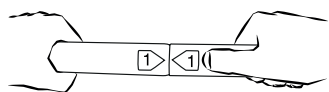
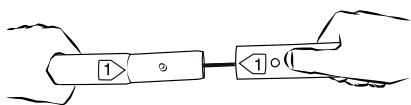
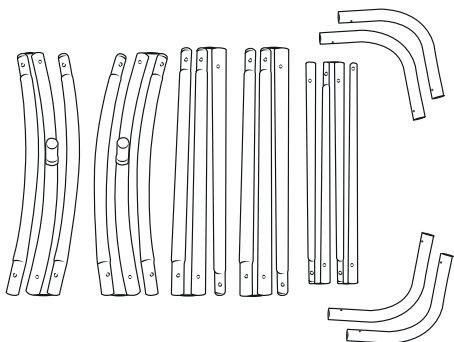
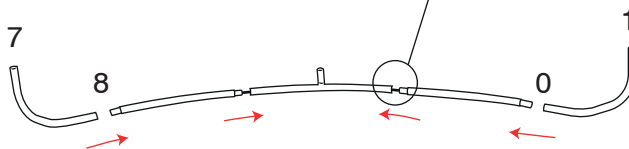

**2**

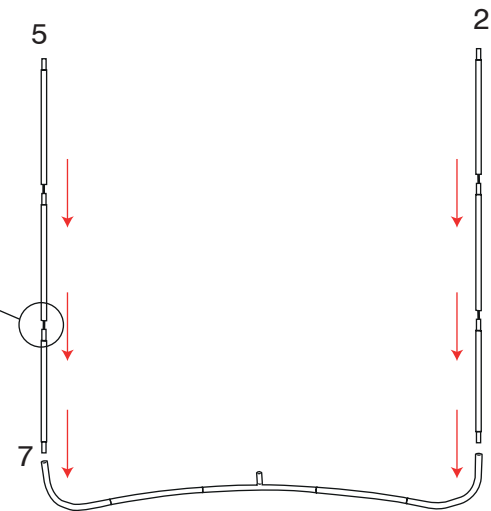

**3**

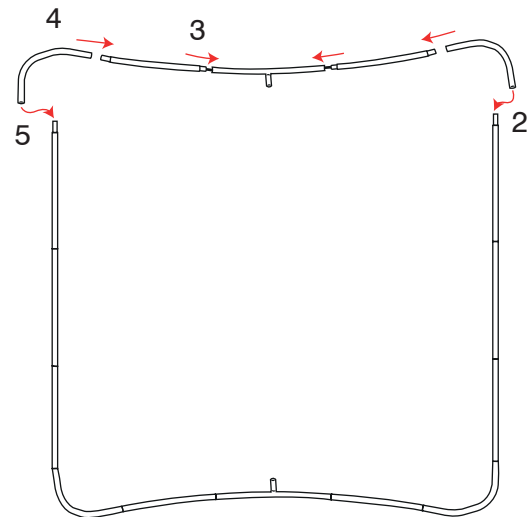

**4**

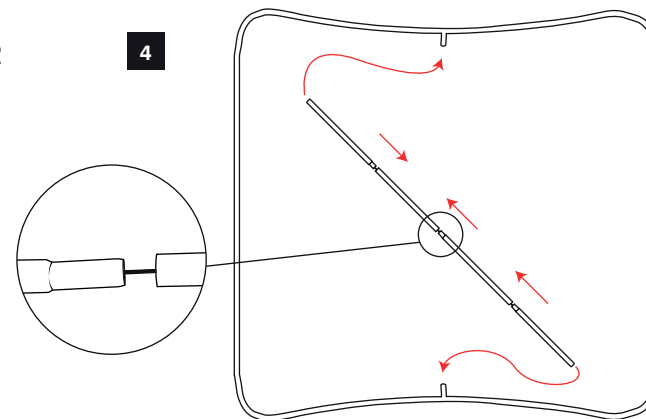

# Montage mur d'image courbe

5

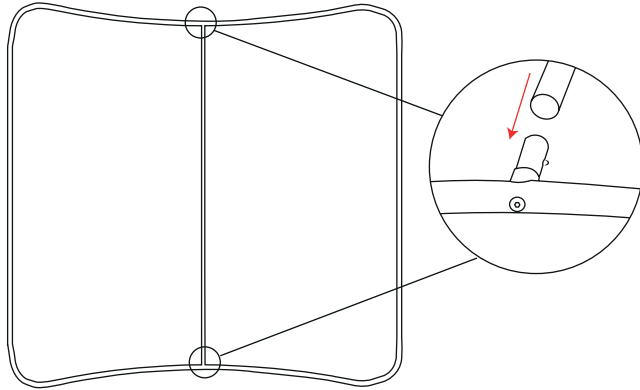

6

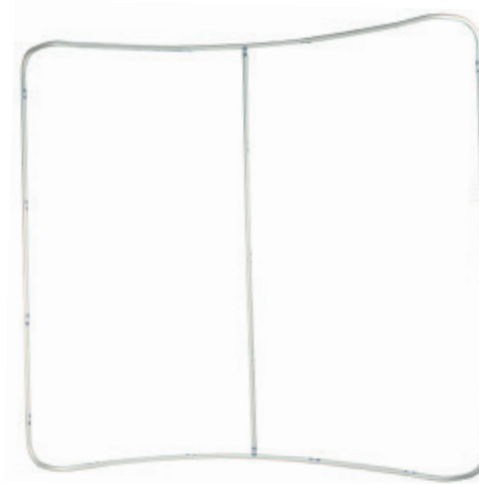

## Montage du visuel

- 1** Enfilez le visuel sur la structure par le haut.  
Si besoin utilisez des gants pour éviter de salir votre visuel.

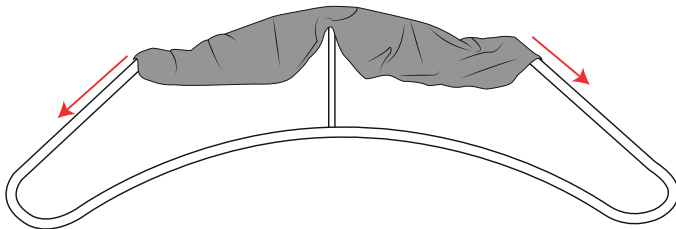

2

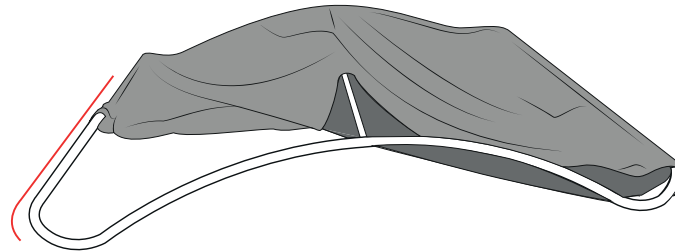

- 3** Fermez celui-ci à l'aide de la fermeture Éclair.

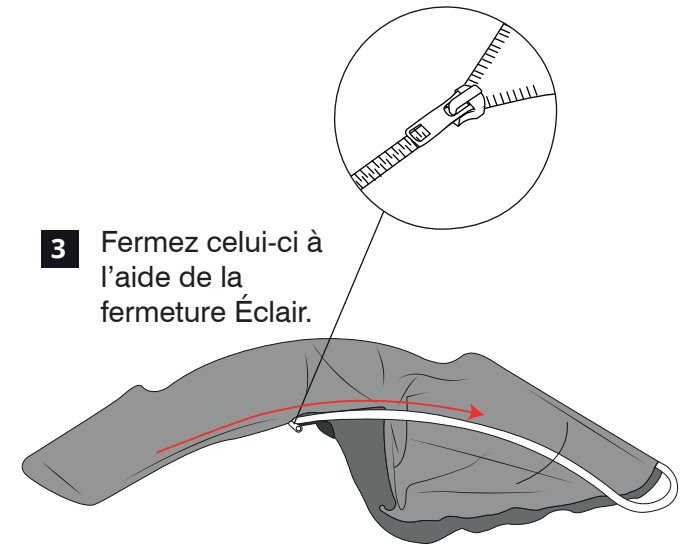

# Montage mur d'image courbe

## Montage de la structure 6m

1

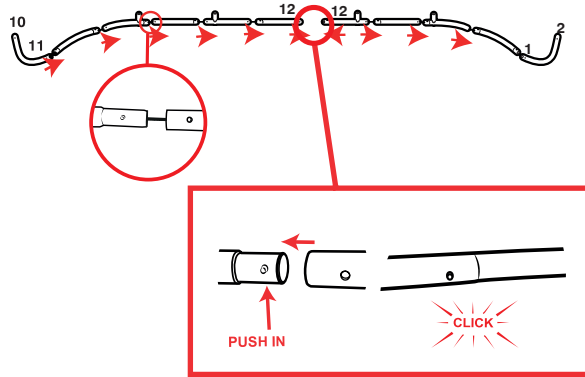

2

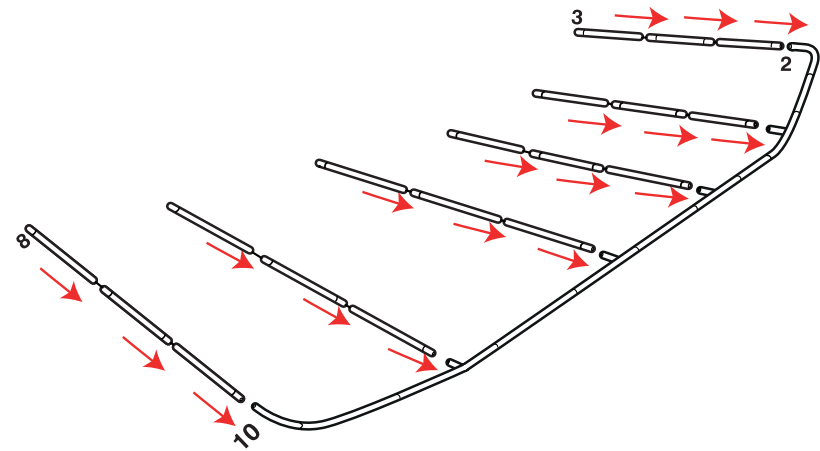

3

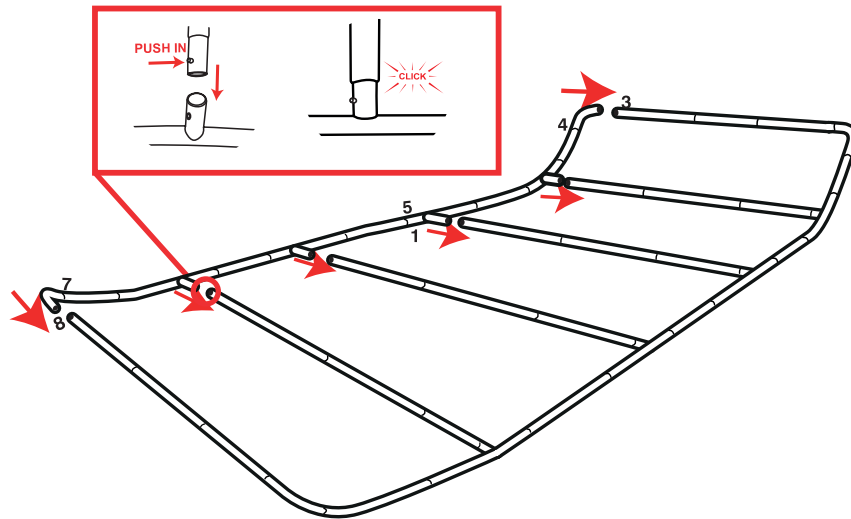

# Montage mur d'image courbe

## Montage du visuel

1

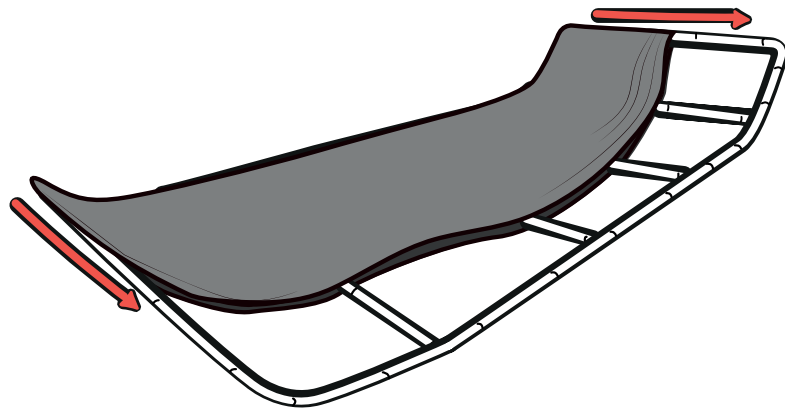

2

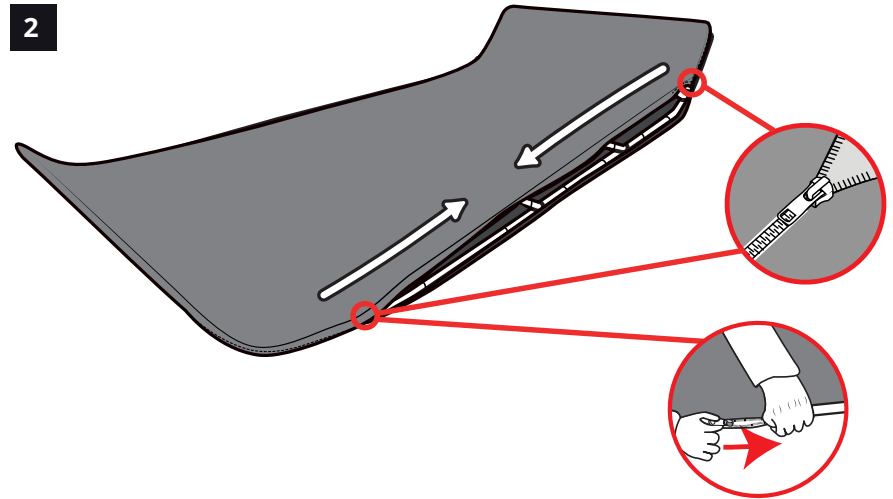

3

